

H510/520 serie  
WD142 bar

HD HASPEL VOOR VETTEN EN HYDRAULISCHE OLIE  
HIGH PRESSURE GREASE / HYDRAULIC OIL REELS

Omschrijving

- Plaatstalen constructie voorzien van corrosie bestendige poeder coating.
- U-vormige bevestigingsbeugel voorzien van lengte rillen voor hogere stabiliteit.

- Slanggeleider met 4 rollers voor een goede doorvoering en verstelbaar in 9 posities, geschikt voor montage op muur, plafond en vloer
- Veer volledig opgesloten en gesmeerd
- Lekvrije swivel met volle doorlaat

Product Description

- HD steel construction with corrosion resistant powder coating
- U-shaped base with groove reinforcement ensures stable support
- Four direction non-snag rollers reduce hose wear abrasion
- Multi position ratchet lock and easy tension adjustment.
- Spring fully enclosed and lubricated
- Full flow swivel prevents leakage
- Guide arm adjustable for handling up to 9 positions permits wall, ceiling or floor mount.

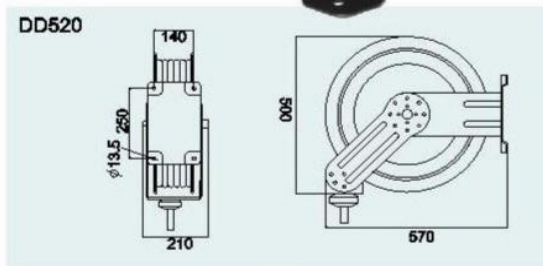
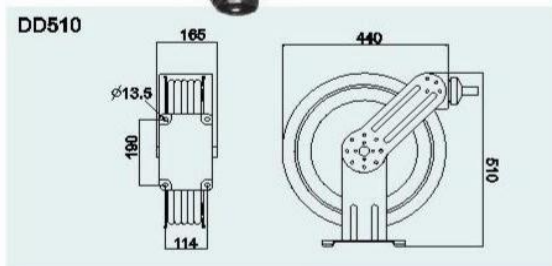

Model	H5101506 (DD510-1-50)	H5101510 (DD510-2-50)	H5201512 (DD520-3-50)
Slangtype	SAE 100R1 AT - SAE 100R17		
Slanglengte	15 meter		
Slang diameter	1/4 inch	3/8 inch	1/2 inch
Inlaat/uitlaat	1/4 inch	3/8 inch	1/2 inch
Werkdruk	196 bar	160 bar	142 bar
Afmeting verpakking	47 x 19 x 50 cm		54 x 22 x 59 cm
Netto/bruto gewicht	18 / 19 kg	21 / 22 kg	28 / 29.5 kg

L140  
WD 20 bar

HASPEL VOOR LUCHT  
AIR HOSE REEL

Omschrijving

- Hoogwaardige constructie vervaardigd van een hoge kwaliteit polypropyleen.
- Een veerbelaste, automatische stop vergrendeld de slang op de door U gewenste lengte.
- Geïntegreerde bevestigingsbeugel.
- Leverbaar met PU en/of PVC slang.

Product Description

- Durable construction made from high quality impact resistant polypropylene
- Positive latching mechanism automatically locks hose at desired length.
- Integral wall/overhead swivel bracket
- PU and PVC hoses available

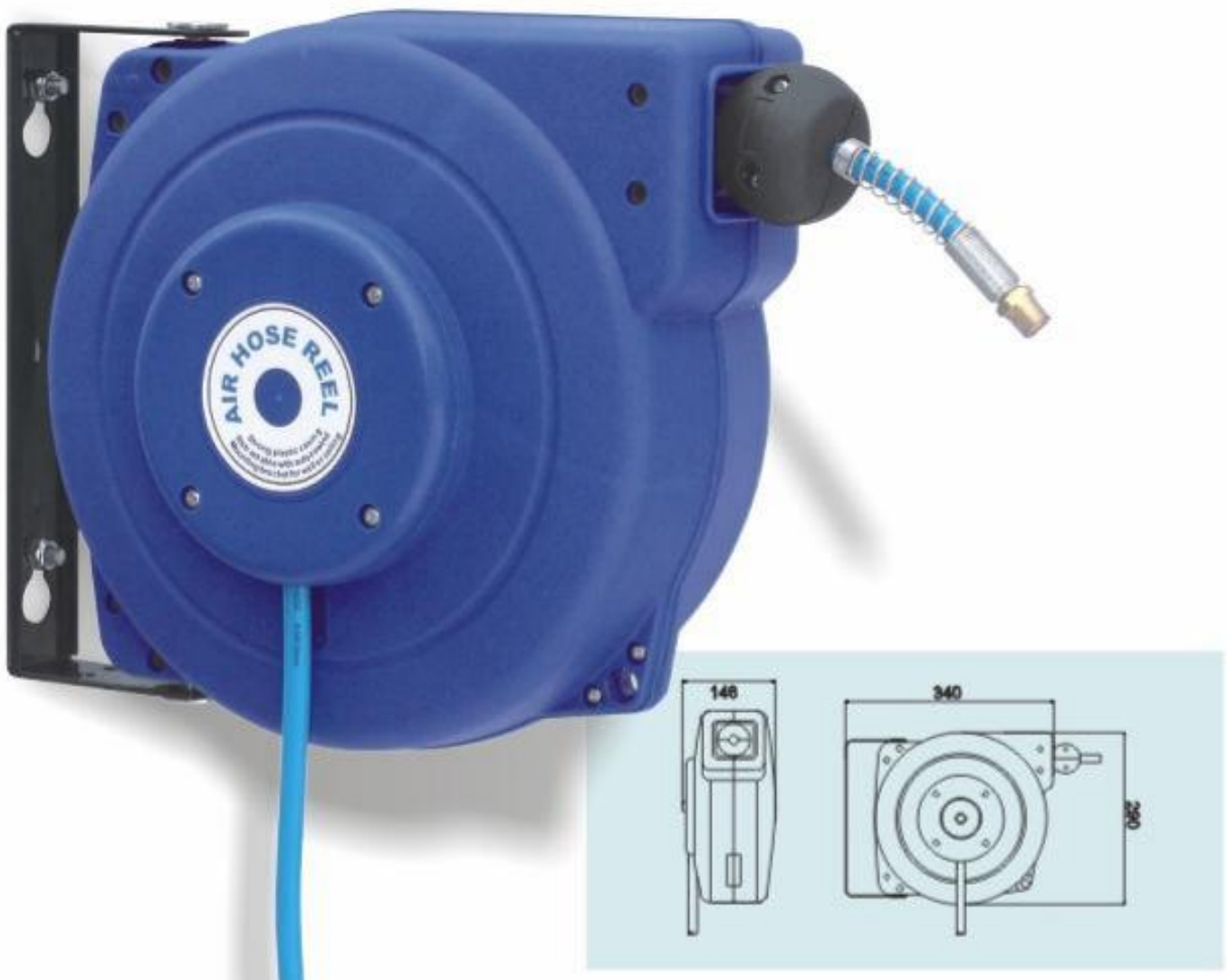

Model	L14012-06 (DA140-5-39-P180)
Slangmateriaal	PU met inlage
Slanglengte	12 meter
Slang diameter	6.5 x 10 mm
Inlaat/uitlaat	1/4 inch
Werkdruk	20 bar
Afmeting verpakking	33 x 18 x 33.5 cm
Netto/bruto gewicht	14 - 16 kg

**L510/520 SERIE**  
WD 21 bar

**HASPEL VOOR LUCHT**  
**AIR HOSE REEL**

Omschrijving

- Plaatstalen constructie voorzien van corrosie bestendige poeder coating, veer volledig opgesloten en gesmeerd.
- U-vormige bevestigingsbeugel voorzien van lengte rillen voor hogere stabiliteit.
- Slanggeleider met 4 rollers voor een goede doorvoering en verstelbaar in 9 posities, geschikt voor montage op muur, plafond en vloer, lekvrije swivel met volle doorlaat.

Product Description

- Heavy ribbed steel plate to ensure strong support
- Spring locates in the middle to ensure stability of the reel and fully enclosed and lubricated
- Guide arm adjustable for handling up to 9 positions per-mits wall, ceiling or floor mount.
- Elegant appearance, dual pedestal base
- Special swivel joint for easy maintenance and repair
- Ball bearing swivel joint structure largely reducing the friction between swivel spool and swivel body

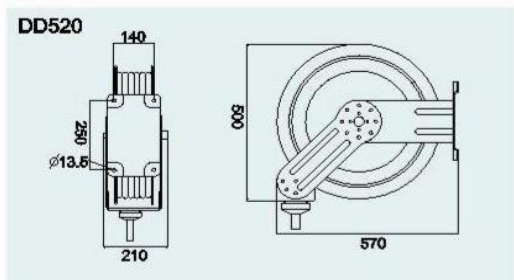
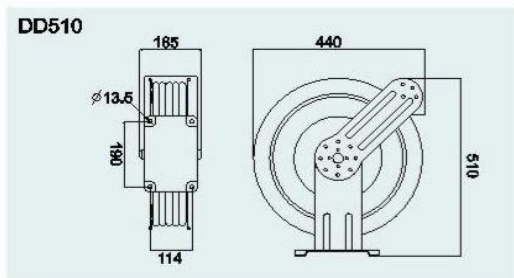

Model	L5101510 (DD510-2-50-P300)	L5203010 (DD520-2-100-P300)	L5201512 (DD520-3-50-P300)
Slangtype	Rubberslang		
Slanglengte	15 meter	30 meter	15 meter
Slang diameter	3/8 inch		1/2 inch
Inlaat/uitlaat	1/4 inch of 3/8 inch		3/8 of 1/2 inch
Werkdruk	21.4 bar		
Afmeting verpakking	47 x 19 x 50 cm	54 x 22 x 59 cm	
Netto/bruto gewicht	18 / 19 kg	29 / 30.5 kg	27 / 28 kg

**H710 SERIE**  
WD 200 bar

**HASPEL VOOR LUCHT/WATER**  
*AIR/WATER HOSE REEL*

Omschrijving

- Ontwikkeld voor industriële toepassingen waar langere lengte slang benodigd is,
- Zware plaatstalen constructie met verstevigingrillen in de haspelbladen.
- Volle doorlaat swivel joint.
- Een veerbelaste vergrendeling is op aanvraag verkrijgbaar teneinde het afrollen van de slang tegen te gaan.
- Op bestelling ook verkrijgbaar in een WD 200 bar uitvoering.

Product Description

- Designed for industrial applications where longer length of hose is required.
- Constructed with heavy duty powder coated steel
- Full flow swivel joint folded handling
- Open hose drum design
- Spring loaded lock pin available to prevent hose from de-reeling.
- Large reeling capacity

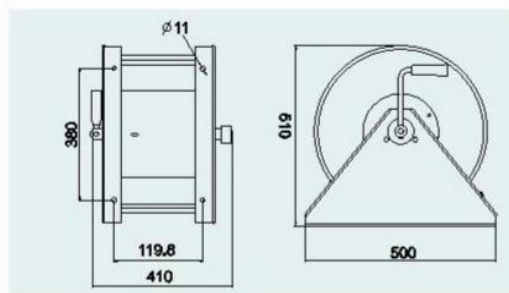

Model	H7109006 (DB710-2-300-P300)
Slangtype	Zonder slang / without hose
Slanglengte (geschikt voor /Suitable for)	91 meter
Slang diameter	1/4 inch
Inlaat/uitlaat	1/4 inch of 3/8 inch
Werkdruk - barstdruk	200 bar
Afmeting verpakking	52 x 39 x 50,5 cm
Netto/bruto gewicht	12 / 14,5 kg

W330  
WD 21 bar

**ACETYLEEN & ZUURSTOF HASPEL**  
*TWIN WELDING HOSE REEL*

Omschrijving

- Plaatstalen constructie voorzien van corrosie bestendige poeder coating.
- L-vormige bevestigingsbeugel voorzien van lengte rillen voor hogere stabiliteit.
- Slanggeleider met 4 rollers voor een goede doorvoering en verstelbaar in 9 posities, geschikt voor montage op muur, plafond en vloer.
- Veer volledig opgesloten en gesmeerd.
- Lekkvrije swivel met volle doorlaat.
- Acetyleen 3/8 inch & zuurstof 1/4 inch (twin) slang.
- Lekkvrije pakking voorzien van 2 O-ringen.

Product Description

- HD steel construction with corrosion resistant powder coating
- L-shaped base with groove reinforcement ensures stable support
- Four direction non-sag rollers reduce hose wear abrasion
- Multi position ratchet lock and easy tension adjustment.
- Spring fully enclosed and lubricated
- Guide arm adjustable for handling up to 9 positions permits wall, ceiling or floor mount.
- 1/4 inch oxygen and 3/8 inch acetylene twin hose.
- Leak proof double O-ring seals



*Deze haspel wordt standaard voorzien van een tweelingslang, t.w.;*

- *Acetyleenslang - kleur rood - diameter 3/8 inch*
- *Zuurstofslang - kleur blauw - diameter 1/4 inch*

*De swivel wordt standaard NIET door ons gemonteerd i.v.m. mogelijke transportschade, maar door ons los bijgeleverd en dient door Uzelf gemonteerd te worden.*

Model	W33015006 (DB330D-1-65-P300)
Slangtype	Acetyleen - Zuurstofslang - tweelingslang
Slangdiameter	Zuurstofslang - blauw 1/4 inch - acetyleenslang - rood 3/8 inch
Slanglengte	15 meter
Inlaat/uitlaat	1/4 of 9/16" x 18 UNF (2B) messing wartels
Werkdruk	21 bar
Afmeting verpakking	52.5 x 26 x 56,5 cm
Netto/bruto gewicht	24.3 / 26 kg

**E145 SERIE**  
NED - 2000 watt

**ELECTRISCH KABEL HASPEL**  
*CABLE REEL*

Omschrijving

- PVC - kabel welke vrij van torsie, eenvoudig en beschermd in de kunststof behuizing wordt opgeborgen.
- Een beveiliging tegen overbelasting is beschikbaar.
- Muur & plafond montage .
- Polypropyleen behuizing, slagbestendig.
- Instelbare stop en 2-weg rollers voor een goede geleiding.
- TÜV - CE goedgekeurd.

Product Description

- Tangle free encased plastic cable for easy winding and protection during storage
- Spring retractable with latch
- Wall or ceiling mounting with 180° swivel for easy handling
- High quality impact resistant polypropylene case
- Adjustable cord stop, 2-roller non snag cord guide
- TÜV - CE - approved



Model	E14615 (DL146-4-50)
Kabel specificatie	Neopreen kabel - 3 x 1,50 mm <sup>2</sup>
Kabellengte	15 meter
Uitvoering	Stekker - 230 Volt
watt	2750 watt (opgerold 1000 watt)
Netto/bruto gewicht	22 - 24.5 kg
Afmeting verpakking	34.5 x 18 x 33 cm

**L250 SERIE**  
WD 21 bar

**HASPEL VOOR LUCHT - HANDBEDIEND**  
*MANUEL AIR HOSE REEL*

Omschrijving

- Een universeel draagbare constructie.
- Frame vervaardigd van hoogwaardige buisframe.
- Corrosie bestendig poeder gecoat.
- Instelbare trek beveiliging.
- Solide messing swivel.
- PVC slang.

Product Description

- Universal rotation
- Heavy duty steel frame structure
- Corrosion resistant powder coating
- Adjustable drag brake
- Solid brass swivel
- Including 43" lead-in hose, 360° pivot base
- PVC hose

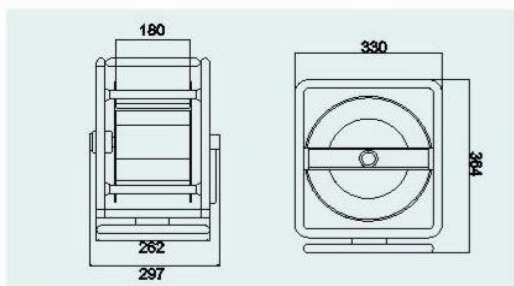

Model	L2503006 (DB250-2-300-P300)
Slangtype	PVC met inlage
Slanglengte	30 meter
Slang diameter	1/4 inch
Inlaat/uitlaat	1/4 inch
Werkdruk - barstdruk	21 bar - 64 bar
Afmeting verpakking	34 x 30 x 37 cm
Netto/bruto gewicht	9.5 / 11 kg

**B3300 SERIE**  
**BEUGELS**

**BEUGELS VOOR MUUR-WAND-VLOER MONTAGE**  
*SWIVEL WALL MOUNT FOR HOSE REEL*

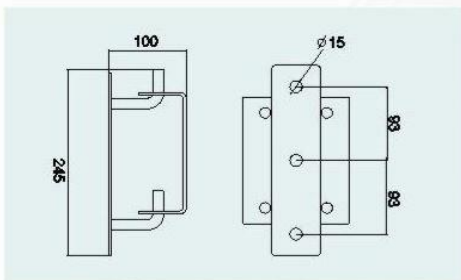

**MODEL B3311**

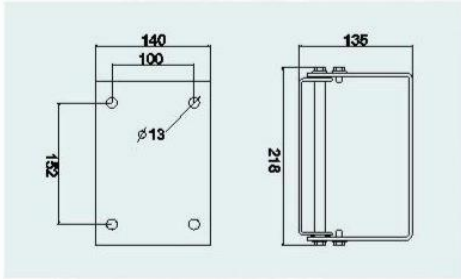

**MODEL B3321**

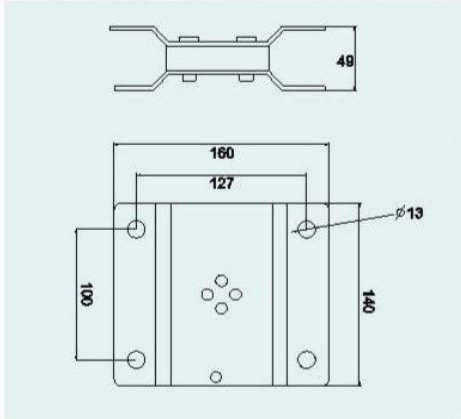

**MODEL B3331**

Model	B3311	B3321	B3331
Netto/bruto gewicht	16 / 17 kg	18 / 19 kg	23 / 24 kg
Afmetingen	28 x 8.5 x 14 cm	22 x 14 .5 x 15 cm	17 x 16.5 x 5,5 cm
Afmetingen verpakking	36 x 26 x 30 cm (8 sts)	45 x 22.5 x 33 cm (6 sts)	53 x 17.5 x 29 cm (15 sts )



- Part-no: HS006      Rubberslangstop voor slang 06 mm
- Part-no: HS010      Rubberslangstop voor slang 10 mm
- Part-no: HS012      Rubberslangstop voor slang 12 mm
- Part-no: HSNEO      Rubberslangstop voor PVC/NEO kabel
- Part-no: HSWEL      Rubberslangstop voor TWIN slang

Geachte relatie,

Het doet ons veel genoegen U bijgaand onze nieuwe documentatie van Slangklemmen te kunnen overhandigen. Met dit sterk verbeterde en uitgebreide pakket klemmen kunt U naar alle waarschijnlijkheid alle oplossingen vinden die binnen deze producten voorhanden zijn.

De merknamen ESMA - ESPA en ESNO staan voor de kwaliteit die U van ons gewend bent en van ons mag verwachten. De prijs/kwaliteitverhouding zal U dan ook zeer zeker bevallen.



## Leidingklemmen

**Materiaal : staal & RVS**

## “FIXING” clamps

**Materiaal : Steel & SS**

**W1 = zinkplated staal**

**W4 = RVS 304**

Deze klemmen worden alleen op bestelling geleverd  
levertijd plm 6 tot 8 weken

The time of delivery for above clamps is approx. 6 to 8 weeks.

Dia	9 mm breed		12 mm breed		15 mm breed		20 mm breed		25 mm breed	
	W1	W4	W1	W4	W1	W4	W1	W4	W1	W4
04	GLS0904	GLR0904	GLS1204	GLR1204	GLS1504	GLR1504	GLS2004	GLR2004	GLS2504	GLR2504
06	GLS0906	GLR0906	GLS1206	GLR1206	GLS1506	GLR1506	GLS2006	GLR2006	GLS2506	GLR2506
08	GLS0908	GLR0908	GLS1208	GLR1208	GLS1508	GLR1508	GLS2008	GLR2008	GLS2508	GLR2508
10	GLS0910	GLR0910	GLS1210	GLR1210	GLS1510	GLR1510	GLS2010	GLR2010	GLS2510	GLR2510
12	GLS0912	GLR0912	GLS1212	GLR1212	GLS1512	GLR1512	GLS2012	GLR2012	GLS2512	GLR2512
14	GLS0914	GLR0914	GLS1214	GLR1214	GLS1514	GLR1514	GLS2014	GLR2014	GLS2514	GLR2514
16	GLS0916	GLR0916	GLS1216	GLR1216	GLS1516	GLR1516	GLS2016	GLR2016	GLS2516	GLR2516
18	GLS0918	GLR0918	GLS1218	GLR1218	GLS1518	GLR1518	GLS2018	GLR2018	GLS2518	GLR2518
20	GLS0920	GLR0920	GLS1220	GLR1220	GLS1520	GLR1520	GLS2020	GLR2020	GLS2520	GLR2520
22	GLS0922	GLR0922	GLS1222	GLR1222	GLS1522	GLR1522	GLS2022	GLR2022	GLS2522	GLR2522
24	GLS0924	GLR0924	GLS1224	GLR1224	GLS1524	GLR1524	GLS2024	GLR2024	GLS2524	GLR2524
26	GLS0926	GLR0926	GLS1226	GLR1226	GLS1526	GLR1526	GLS2026	GLR2026	GLS2526	GLR2526
28	GLS0928	GLR0928	GLS1228	GLR1228	GLS1528	GLR1528	GLS2028	GLR2028	GLS2528	GLR2528
30	GLS0930	GLR0930	GLS1230	GLR1230	GLS1530	GLR1530	GLS2030	GLR2030	GLS2530	GLR2530
32	GLS0932	GLR0932	GLS1232	GLR1232	GLS1532	GLR1532	GLS2032	GLR2032	GLS2532	GLR2532
34	GLS0934	GLR0934	GLS1234	GLR1234	GLS1534	GLR1534	GLS2034	GLR2034	GLS2534	GLR2534
36	GLS0936	GLR0936	GLS1236	GLR1236	GLS1536	GLR1536	GLS2036	GLR2036	GLS2536	GLR2536
38	GLS0938	GLR0938	GLS1238	GLR1238	GLS1538	GLR1538	GLS2038	GLR2038	GLS2538	GLR2538
40	GLS0940	GLR0940	GLS1240	GLR1240	GLS1540	GLR1540	GLS2040	GLR2040	GLS2540	GLR2540
42	GLS0942	GLR0942	GLS1242	GLR1242	GLS1542	GLR1542	GLS2042	GLR2042	GLS2542	GLR2542
44	GLS0944	GLR0944	GLS1244	GLR1244	GLS1544	GLR1544	GLS2044	GLR2044	GLS2544	GLR2544
46	GLS0946	GLR0946	GLS1246	GLR1246	GLS1546	GLR1546	GLS2046	GLR2046	GLS2546	GLR2546
48	GLS0948	GLR0948	GLS1248	GLR1248	GLS1548	GLR1548	GLS2048	GLR2048	GLS2548	GLR2548
50	GLS0950	GLR0950	GLS1250	GLR1250	GLS1550	GLR1550	GLS2050	GLR2050	GLS2550	GLR2550
52	GLS0952	GLR0952	GLS1252	GLR1252	GLS1552	GLR1552	GLS2052	GLR2052	GLS2552	GLR2552
54	GLS0954	GLR0954	GLS1254	GLR1254	GLS1554	GLR1554	GLS2054	GLR2054	GLS2554	GLR2554
56	GLS0956	GLR0956	GLS1256	GLR1256	GLS1556	GLR1556	GLS2056	GLR2056	GLS2556	GLR2556
58	GLS0958	GLR0958	GLS1258	GLR1258	GLS1558	GLR1558	GLS2058	GLR2058	GLS2558	GLR2558
60	GLS0960	GLR0960	GLS1260	GLR1260	GLS1560	GLR1560	GLS2060	GLR2060	GLS2560	GLR2560



## ESPA 1-delig - 24 mm

**Materiaal : W1**  
**afmeting 20 x 1 mm, bout M6 x 45/8.8 G**

## ESPA 1-bolt - 24 mm

**Material : W1**  
**size 20 x 1 mm, bolt M6 x 45/8.8 G**

Eteha art. no:	Omschrijving (Discription)	Materiaal (Material)
GEP0A030	ESPA-klem - 1-delig - 022 - 031 mm	W1
GEP0A035	ESPA-klem - 1-delig - 030 - 036 mm	W1
GEP0A040	ESPA-klem - 1-delig - 035 - 041 mm	W1
GEP0A045	ESPA-klem - 1-delig - 040 - 046 mm	W1
GEP0A050	ESPA-klem - 1-delig - 045 - 051 mm	W1
GEP0A055	ESPA-klem - 1-delig - 050 - 056 mm	W1
GEP0A058	ESPA-klem - 1-delig - 053 - 059 mm	W1
GEP0A060	ESPA-klem - 1-delig - 055 - 061 mm	W1
GEP0A065	ESPA-klem - 1-delig - 060 - 067 mm	W1
GEP0A070	ESPA-klem - 1-delig - 065 - 072 mm	W1
GEP0A075	ESPA-klem - 1-delig - 070 - 077 mm	W1
GEP0A080	ESPA-klem - 1-delig - 075 - 082 mm	W1
GEP0A085	ESPA-klem - 1-delig - 080 - 087 mm	W1
GEP0A090	ESPA-klem - 1-delig - 085 - 092 mm	W1
GEP0A095	ESPA-klem - 1-delig - 090 - 097 mm	W1
GEP0A100	ESPA-klem - 1-delig - 095 - 102 mm	W1
GEP0A105	ESPA-klem - 1-delig - 098 - 109 mm	W1
GEP0A110	ESPA-klem - 1-delig - 105 - 112 mm	W1
GEP0A115	ESPA-klem - 1-delig - 110 - 117 mm	W1
GEP0A120	ESPA-klem - 1-delig - 115 - 122 mm	W1
GEP0A125	ESPA-klem - 1-delig - 120 - 127 mm	W1
GEP0A145	ESPA-klem - 1-delig - 140 - 147 mm	W1
GEP0A155	ESPA-klem - 1-delig - 150 - 157 mm	W1



### Leveringsvoorwaarden

- Betaling : Binnen 30 dagen na factuurdatum netto, tenzij anders overeengekomen  
Binnen 8 dagen na factuurdatum 2% korting over netto goederenbedrag
- Prijzen : Vrijblijvend, exclusief BTW  
Voor order beneden € 25,00 wordt € 5,00 administratiekosten in rekening gebracht
- Snijtoeslag : 20%, met een minimum van € 7,50
- Levering : Vanaf € 750,00 netto goederenbedrag : franko huis Nederland  
Onder de € 750,00 netto goederenbedrag : vracht op rekening  
Expresszendingen : vracht op rekening
- Retourzendingen : Alleen na voorafgaand overleg

Leveringen geschieden conform de algemene leverings- & betalingsvoorwaarden DPRA - gedeponeed onder no:06/31 bij de Arrondissementsrechtbank te Alkmaar welke zijn te downloaden van onze website [www.eteha.nl](http://www.eteha.nl)



## ESPA 2-delig - 24 mm

Materiaal : W1  
afmeting 25 x 1 mm, bouten M8 x 60/8.8 G

## ESPA 2-bolts - 24 mm

Material : W1  
size 25 x 1 mm, bolt M8 x 60/8.8 G

Eteha art. no.	Omschrijving (Discription)	Materiaal (Material)
GEP2A090	ESPA-klem - 2-delig - 082 - 098 mm.	W1
GEP2A095	ESPA-klem - 2-delig - 087 - 103 mm.	W1
GEP2A100	ESPA-klem - 2-delig - 092 - 108 mm.	W1
GEP2A105	ESPA-klem - 2-delig - 096 - 113 mm.	W1
GEP2A110	ESPA-klem - 2-delig - 100 - 118 mm.	W1
GEP2A115	ESPA-klem - 2-delig - 105 - 123 mm.	W1
GEP2A120	ESPA-klem - 2-delig - 110 - 128 mm.	W1
GEP2A125	ESPA-klem - 2-delig - 115 - 133 mm.	W1
GEP2A130	ESPA-klem - 2-delig - 120 - 138 mm.	W1
GEP2A135	ESPA-klem - 2-delig - 125 - 143 mm.	W1
GEP2A140	ESPA-klem - 2-delig - 130 - 148 mm.	W1
GEP2A145	ESPA-klem - 2-delig - 135 - 153 mm.	W1
GEP2A150	ESPA-klem - 2-delig - 140 - 158 mm.	W1
GEP2A155	ESPA-klem - 2-delig - 144 - 163 mm.	W1
GEP2A160	ESPA-klem - 2-delig - 148 - 168 mm.	W1
GEP2A165	ESPA-klem - 2-delig - 155 - 173 mm.	W1
GEP2A170	ESPA-klem - 2-delig - 160 - 178 mm.	W1
GEP2A175	ESPA-klem - 2-delig - 165 - 183 mm.	W1
GEP2A180	ESPA-klem - 2-delig - 170 - 188 mm.	W1
GEP2A185	ESPA-klem - 2-delig - 175 - 193 mm.	W1
GEP2A190	ESPA-klem - 2-delig - 180 - 198 mm.	W1
GEP2A195	ESPA-klem - 2-delig - 185 - 203 mm.	W1
GEP2A200	ESPA-klem - 2-delig - 190 - 208 mm.	W1
GEP2A210	ESPA-klem - 2-delig - 200 - 218 mm.	W1
GEP2A215	ESPA-klem - 2-delig - 205 - 223 mm.	W1
GEP2A220	ESPA-klem - 2-delig - 210 - 228 mm.	W1
GEP2A227	ESPA-klem - 2-delig - 217 - 235 mm.	W1
GEP2A230	ESPA-klem - 2-delig - 220 - 238 mm.	W1
GEP2A235	ESPA-klem - 2-delig - 225 - 243 mm.	W1
GEP2A240	ESPA-klem - 2-delig - 230 - 248 mm.	W1
GEP2A245	ESPA-klem - 2-delig - 235 - 253 mm.	W1
GEP2A250	ESPA-klem - 2-delig - 240 - 258 mm.	W1
GEP2A255	ESPA-klem - 2-delig - 245 - 263 mm.	W1
GEP2A260	ESPA-klem - 2-delig - 250 - 268 mm.	W1
GEP2A270	ESPA-klem - 2-delig - 260 - 278 mm.	W1
GEP2A275	ESPA-klem - 2-delig - 265 - 283 mm.	W1
GEP2A290	ESPA-klem - 2-delig - 280 - 298 mm.	W1
GEP2A300	ESPA-klem - 2-delig - 290 - 308 mm.	W1

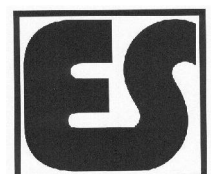



## ESPA 1-delig - 24 mm

**Materiaal : RVS (AISI 304)**

**afmeting 20 x 1 mm, bouten M6 x 45/8.8 G**

## ESPA 1-bolt - 24 mm

**Material : Stainless Steel (AISI 304)**

**size 20 x 1 mm, bolt M6 x 45/8.8 G**

**Materiaal / Material : SS-304**

Eteha at.no.	Omschrijving (Discription)	Materiaal (Material)
GEPR0A030	ESPA-klem - 1-delig - 022 - 031 mm	W4
GEPR0A035	ESPA-klem - 1-delig - 030 - 036 mm	W4
GEPR0A040	ESPA-klem - 1-delig - 035 - 041 mm	W4
GEPR0A045	ESPA-klem - 1-delig - 040 - 046 mm	W4
GEPR0A050	ESPA-klem - 1-delig - 045 - 051 mm	W4
GEPR0A055	ESPA-klem - 1-delig - 050 - 056 mm	W4
GEPR0A058	ESPA-klem - 1-delig - 053 - 059 mm	W4
GEPR0A060	ESPA-klem - 1-delig - 055 - 061 mm	W4
GEPR0A065	ESPA-klem - 1-delig - 060 - 067 mm	W4
GEPR0A070	ESPA-klem - 1-delig - 065 - 072 mm	W4
GEPR0A075	ESPA-klem - 1-delig - 070 - 077 mm	W4
GEPR0A080	ESPA-klem - 1-delig - 075 - 082 mm	W4
GEPR0A085	ESPA-klem - 1-delig - 080 - 087 mm	W4
GEPR0A090	ESPA-klem - 1-delig - 085 - 092 mm	W4
GEPR0A095	ESPA-klem - 1-delig - 090 - 097 mm	W4
GEPR0A100	ESPA-klem - 1-delig - 095 - 102 mm	W4
GEPR0A105	ESPA-klem - 1-delig - 100 - 109 mm	W4
GEPR0A110	ESPA-klem - 1-delig - 105 - 112 mm	W4
GEPR0A115	ESPA-klem - 1-delig - 110 - 117 mm	W4
GEPR0A120	ESPA-klem - 1-delig - 115 - 122 mm	W4
GEPR0A125	ESPA-klem - 1-delig - 120 - 127 mm	W4
GEPR0A130	ESPA-klem - 1-delig - 125 - 132 mm	W4
GEPR0A135	ESPA-klem - 1-delig - 130 - 137 mm	W4
GEPR0A140	ESPA-klem - 1-delig - 135 - 142 mm	W4
GEPR0A145	ESPA-klem - 1-delig - 140 - 147 mm	W4
GEPR0A150	ESPA-klem - 1-delig - 145 - 152 mm	W4
GEPR0A160	ESPA-klem - 1-delig - 155 - 162 mm	W4
GEPR0A170	ESPA-klem - 1-delig - 165 - 172 mm	W4
GEPR0A180	ESPA-klem - 1-delig - 175 - 182 mm	W4
GEPR0A190	ESPA-klem - 1-delig - 185 - 192 mm	W4
GEPR0A200	ESPA-klem - 1-delig - 195 - 203 mm	W4

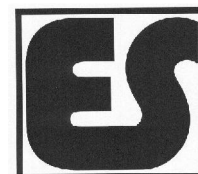



**ESPA 2-delig - 24 mm**

Materiaal : RVS (AISI 304)  
afmeting 20 x 1 mm, bouten M6 x 45/8.8 G

**ESPA 2-bolts - 24 mm**

Material : Stainless Steel (AISI 304)  
size 20 x 1 mm, bolt M6 x 45/8.8 G

**Materiaal / Material : SS-304**

Eteha art.no.	Omschrijving (Discription)	Materiaal (Material)
GEPR1A050	ESPA-klem - 2-delig - 042 - 054 mm.	W4
GEPR1A055	ESPA-klem - 2-delig - 047 - 057 mm.	W4
GEPR1A060	ESPA-klem - 2-delig - 052 - 064 mm.	W4
GEPR1A065	ESPA-klem - 2-delig - 057 - 069 mm.	W4
GEPR1A070	ESPA-klem - 2-delig - 062 - 074 mm.	W4
GEPR1A075	ESPA-klem - 2-delig - 067 - 079 mm.	W4
GEPR1A080	ESPA-klem - 2-delig - 072 - 084 mm.	W4
GEPR1A085	ESPA-klem - 2-delig - 077 - 089 mm.	W4
GEPR1A090	ESPA-klem - 2-delig - 082 - 094 mm.	W4
GEPR1A095	ESPA-klem - 2-delig - 087 - 099 mm.	W4
GEPR1A100	ESPA-klem - 2-delig - 092 - 104 mm.	W4
GEPR1A115	ESPA-klem - 2-delig - 107 - 119 mm.	W4
GEPR1A120	ESPA-klem - 2-delig - 112 - 124 mm.	W4
GEPR1A130	ESPA-klem - 2-delig - 122 - 134 mm.	W4
GEPR1A140	ESPA-klem - 2-delig - 132 - 144 mm.	W4
GEPR1A150	ESPA-klem - 2-delig - 142 - 154 mm.	W4
GEPR1A160	ESPA-klem - 2-delig - 152 - 164 mm.	W4
GEPR1A170	ESPA-klem - 2-delig - 162 - 174 mm.	W4
GEPR1A175	ESPA-klem - 2-delig - 167 - 179 mm.	W4
GEPR1A180	ESPA-klem - 2-delig - 172 - 184 mm.	W4
GEPR1A190	ESPA-klem - 2-delig - 182 - 194 mm.	W4
GEPR1A200	ESPA-klem - 2-delig - 192 - 204 mm.	W4
GEPR1A225	ESPA-klem - 2-delig - 217 - 229 mm.	W4
GEPR1A270	ESPA-klem - 2-delig - 262 - 274 mm.	W4

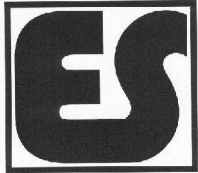



## ESMA wormslangklemmen

**Materiaal : staalband - W1**  
**12 mm breed - afgeronde randen**  
**Normering : Din 3017**

## ESMA wormdrive clips

**Material : steel - W1**  
**12 mm wide - Din 3017**

Eteha art. no.	Omschrijving (Discription)	Materiaal (Material)
GE009	ESMA - wormslangklem - 009 - 012 mm.	W1
GE011	ESMA - wormslangklem - 011 - 016 mm.	W1
GE013	ESMA - wormslangklem - 013 - 020 mm.	W1
GE014	ESMA - wormslangklem - 014 - 022 mm.	W1
GE017	ESMA - wormslangklem - 017 - 025 mm.	W1
GE022	ESMA - wormslangklem - 022 - 030 mm.	W1
GE025	ESMA - wormslangklem - 025 - 035 mm.	W1
GE030	ESMA - wormslangklem - 030 - 040 mm.	W1
GE035	ESMA - wormslangklem - 035 - 050 mm.	W1
GE040	ESMA - wormslangklem - 040 - 055 mm.	W1
GE045	ESMA - wormslangklem - 045 - 060 mm.	W1
GE050	ESMA - wormslangklem - 050 - 070 mm.	W1
GE060	ESMA - wormslangklem - 060 - 080 mm.	W1
GE070	ESMA - wormslangklem - 070 - 090 mm.	W1
GE080	ESMA - wormslangklem - 080 - 100 mm.	W1
GE090	ESMA - wormslangklem - 090 - 120 mm.	W1
GE110	ESMA - wormslangklem - 110 - 140 mm.	W1
GE130	ESMA - wormslangklem - 130 - 160 mm.	W1
GE150	ESMA - wormslangklem - 150 - 180 mm.	W1
GE170	ESMA - wormslangklem - 170 - 200 mm.	W1
GE190	ESMA - wormslangklem - 190 - 220 mm.	W1
GE200	ESMA - wormslangklem - 200 - 231 mm.	W1
GE210	ESMA - wormslangklem - 210 - 240 mm.	W1
GE230	ESMA - wormslangklem - 230 - 260 mm.	W1
GE250	ESMA - wormslangklem - 250 - 280 mm.	W1
GE270	ESMA - wormslangklem - 270 - 300 mm.	W1
GE290	ESMA - wormslangklem - 290 - 320 mm.	W1
GE310	ESMA - wormslangklem - 310 - 340 mm.	W1

Eteha art. no:	Omschrijving (Discription)
----------------	----------------------------

GESD	ESMA flexibele schroevendraaier geschikt voor alle ESMA wormslangklemmen - lengte 28 cm
------	---





## ESMA RVS wormslangklemmen

Materiaal : RVS - W4

12 mm breed - afgeronde randen

## ESMA SS wormdrive clips

Material : stainless steel W4

12 mm wide

**Materiaal / Material : SS-304**

Eteha art. no.	Omschrijving (Discription)	Materiaal (Material)
GER009	ESMA wormslangklem RVS-304 - 09,5 - 012 mm.	W4
GER011	ESMA wormslangklem RVS-304 - 011 - 016 mm.	W4
GER013	ESMA wormslangklem RVS-304 - 013 - 020 mm.	W4
GER014	ESMA wormslangklem RVS-304 - 014 - 022 mm.	W4
GER017	ESMA wormslangklem RVS-304 - 017 - 025 mm.	W4
GER022	ESMA wormslangklem RVS-304 - 022 - 030 mm.	W4
GER025	ESMA wormslangklem RVS-304 - 025 - 035 mm.	W4
GER030	ESMA wormslangklem RVS-304 - 027 - 040 mm.	W4
GER035	ESMA wormslangklem RVS-304 - 035 - 050 mm.	W4
GER040	ESMA wormslangklem RVS-304 - 040 - 055 mm.	W4
GER045	ESMA wormslangklem RVS-304 - 045 - 060 mm.	W4
GER055	ESMA wormslangklem RVS-304 - 055 - 070 mm.	W4
GER060	ESMA wormslangklem RVS-304 - 060 - 080 mm.	W4
GER070	ESMA wormslangklem RVS-304 - 070 - 090 mm.	W4
GER080	ESMA wormslangklem RVS-304 - 080 - 100 mm.	W4
GER085	ESMA wormslangklem RVS-304 - 085 - 105 mm.	W4
GER090	ESMA wormslangklem RVS-304 - 090 - 120 mm.	W4
GER110	ESMA wormslangklem RVS-304 - 110 - 140 mm.	W4
GER120	ESMA wormslangklem RVS-304 - 120 - 140 mm.	W4
GER130	ESMA wormslangklem RVS-304 - 130 - 150 mm.	W4
GER140	ESMA wormslangklem RVS-304 - 140- 160 mm.	W4
GER150	ESMA wormslangklem RVS-304 - 150- 180 mm.	W4
GER170	ESMA wormslangklem RVS-304 - 170- 200 mm.	W4
GER190	ESMA wormslangklem RVS-304 - 190- 220 mm.	W4
GER210	ESMA wormslangklem RVS-304 - 210 - 240 mm.	W4
GER230	ESMA wormslangklem RVS-304 - 230 - 260 mm.	W4
GER250	ESMA wormslangklem RVS-304 - 250 - 280 mm.	W4
GER270	ESMA wormslangklem RVS-304 - 270 - 300 mm.	W4
GER290	ESMA wormslangklem RVS-304 - 290 - 320 mm.	W4
GER310	ESMA wormslangklem RVS-304 - 310 - 340 mm.	W4

Eteha art. no:    Omschrijving (Discription)

GESD    ESMA flexibele schroevendraaier geschikt voor alle ESMA wormslangklemmen - lengte 28 cm

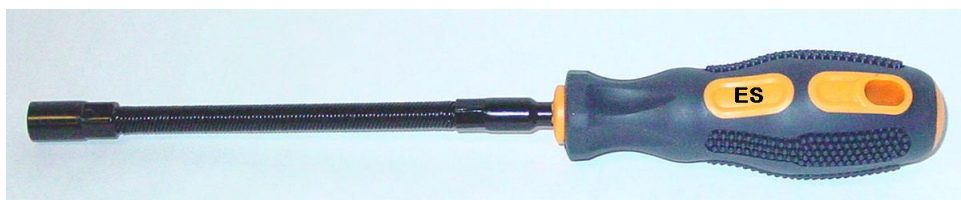



## **SUPER 1-delige slangklemmen**

**Zware uitvoering - Materiaal : W1**  
**Banddikte van 0.6 t/m 1.7 mm**  
**24 mm breed**

## **SUPER 1-bolt hoseclamps**

**Heavy duty - Material : W1**  
**Band wide : from .06 up to 1.7 mm**  
**24 mm wide**

Eteha art.no.	Omschrijving (Discription)	Materiaal (Material)
GS023	SUPER-klem - 1-delig - 023 - 028 mm.	W1
GS026	SUPER-klem - 1-delig - 026 - 028 mm.	W1
GS029	SUPER-klem - 1-delig - 029 - 031 mm.	W1
GS032	SUPER-klem - 1-delig - 032 - 035 mm.	W1
GS036	SUPER-klem - 1-delig - 036 - 039 mm.	W1
GS040	SUPER-klem - 1-delig - 040 - 043 mm.	W1
GS044	SUPER-klem - 1-delig - 044 - 047 mm.	W1
GS048	SUPER-klem - 1-delig - 048 - 051 mm.	W1
GS052	SUPER-klem - 1-delig - 052 - 055 mm.	W1
GS056	SUPER-klem - 1-delig - 056 - 059 mm.	W1
GS060	SUPER-klem - 1-delig - 060 - 063 mm.	W1
GS064	SUPER-klem - 1-delig - 064 - 067 mm.	W1
GS068	SUPER-klem - 1-delig - 068 - 073 mm.	W1
GS074	SUPER-klem - 1-delig - 074 - 079 mm.	W1
GS080	SUPER-klem - 1-delig - 080 - 085 mm.	W1
GS086	SUPER-klem - 1-delig - 086 - 091 mm.	W1
GS092	SUPER-klem - 1-delig - 092 - 097 mm.	W1
GS098	SUPER-klem - 1-delig - 098 - 103 mm.	W1
GS104	SUPER-klem - 1-delig - 104 - 112 mm.	W1
GS113	SUPER-klem - 1-delig - 113 - 121 mm.	W1
GS122	SUPER-klem - 1-delig - 122 - 130 mm.	W1
GS131	SUPER-klem - 1-delig - 131 - 139 mm.	W1
GS140	SUPER-klem - 1-delig - 140 - 148 mm.	W1
GS149	SUPER-klem - 1-delig - 149 - 161 mm.	W1
GS162	SUPER-klem - 1-delig - 162 - 174 mm.	W1
GS175	SUPER-klem - 1-delig - 175 - 187 mm.	W1
GS188	SUPER-klem - 1-delig - 188 - 200 mm.	W1
GS201	SUPER-klem - 1-delig - 201 - 213 mm.	W1
GS214	SUPER-klem - 1-delig - 214 - 226 mm.	W1
GS227	SUPER-klem - 1-delig - 227 - 239 mm.	W1
GS240	SUPER-klem - 1-delig - 240 - 252 mm.	W1

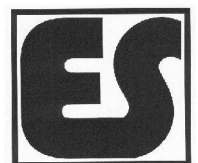



## Slangklemmen - type ESNO

Materiaal : W1

Afmeting : 20 mm breed - 2 bouten

## Hose clamps - type ESNO

Material : W1 - 2 bolts

Size : materiaal 20 mm wide

Deze klemmen worden alleen op bestelling geleverd  
levertijd plm 6 tot 8 weken

The time of delivery for above clamps is approx. 6 to 8 weeks.

Eteha art.no.	Omschrijving (Discription)	Materiaal (Material)
GN037	ESNO-klem - 2-delig - 037 - 043 mm.	W1
GN043	ESNO-klem - 2-delig - 043 - 049 mm.	W1
GN049	ESNO-klem - 2-delig - 049 - 055 mm.	W1
GN055	ESNO-klem - 2-delig - 055 - 063 mm.	W1
GN061	ESNO-klem - 2-delig - 061 - 069 mm.	W1
GN067	ESNO-klem - 2-delig - 067 - 075 mm.	W1
GN073	ESNO-klem - 2-delig - 073 - 081 mm.	W1
GN079	ESNO-klem - 2-delig - 079 - 087 mm.	W1
GN085	ESNO-klem - 2-delig - 085 - 093 mm.	W1
GN089	ESNO-klem - 2-delig - 089 - 095 mm.	W1
GN091	ESNO-klem - 2-delig - 091 - 097 mm.	W1
GN097	ESNO-klem - 2-delig - 097 - 103 mm.	W1



## OOR-klemmen - 2 oortjes

Materiaal 7 mm breed - W1

## “OOR” clamps - 2-ears

Materiaal 7 mm wide - W1

Deze klemmen worden alleen op bestelling geleverd  
levertijd plm 6 tot 8 weken

The time of delivery for above clamps is approx. 6 to 8 weeks.

Eteha art.no.	Omschrijving (Discription)	Materiaal (Material)
	OORJES klem (2-oortjes) - 13 - 15 mm.	W1
	OORJES klem (2-oortjes) - 15 - 18 mm.	W1
	OORJES klem (2-oortjes) - 17 - 20 mm.	W1
	OORJES klem (2-oortjes) - 20 - 23 mm.	W1
	OORJES klem (2-oortjes) - 23 - 27 mm.	W1
	OORJES klem (2-oortjes) - 25 - 28 mm.	W1
	OORJES klem (2-oortjes) - 31 - 34 mm.	W1
	OORJES klem (2-oortjes) - 34 - 37 mm.	W1

## Material overview - hose clamps

- Most frequently used are clamps in W2. For improved corrosion resistance, where needed, we recommend W4 and for environments with high corrosion W5.
- Below you will find more details about the different materials and tractor.
- From the table below you will easily find the corresponding national standards to : W1 up to W5.



Made completely from coated steel. Low requirements in terms of corrosion resistance.  
**Application:** Household appliances, indoor plumbing work.



Band and housing are made from Chrome-Steel AISI 430. The screw is made from zinc plated mild steel. Low to average requirements in terms of corrosion resistance, ensuring that corroded connections can be loosened.  
**Application:** Cars, lorries, mechanical engineering with low requirements in terms of corrosion resistance.



Made entirely from Chrome- Steel AISI 430. W3 is seldom used – exclusively in original equipment. Medium requirements in terms of corrosion resistance.  
**Application:** Automotive sector.



Made entirely from Nickel- Chrome- Steel AISI 304 (or a comparable steel), also known as V2A. A special feature of this austenitic steel is its shiny, durable surface. High requirements in terms of corrosion resistance and design.  
**Application:** For critical connections in cars such as petrol pipes (SM 9 Clamps made from W4), top grade mechanical engineering, agricultural machinery, motorbikes, for attaching signs and hoses outdoors, stainless steel chimneys.



Made entirely from Nickel- Chrome-Molybdenum-Steel AISI 316, also known as V4A. W5 is salt water resistant and can hardly be magnetised. Maximum requirements in terms of corrosion resistance. Used close to critical and electronic circuit arrangements.  
**Application:** In shipbuilding, defence technology, the foodstuffs industry, sewage treatment works, the chemical industry and mechanical engineering entailing top requirements





Haspels en klemmen voor ELK denkbare toepassing



Eteha bv - Slangtechniek  
Postbus 101  
NL3350 AC Papendrecht

Warehouse : Ketelweg 89  
NL3356LD Papendrecht

T : +31-78-6159015  
F : +31-78-6158474  
W : [www.eteha.nl](http://www.eteha.nl)  
E : [eteha@eteha.nl](mailto:eteha@eteha.nl)